

FutureNow FNIP-8x16Av5 Installation and Operations Manual

rev 30.3.2026

8 Channel Relay Switch with Local Inputs and IP communication
/DIN Rail and Surface Mountable/

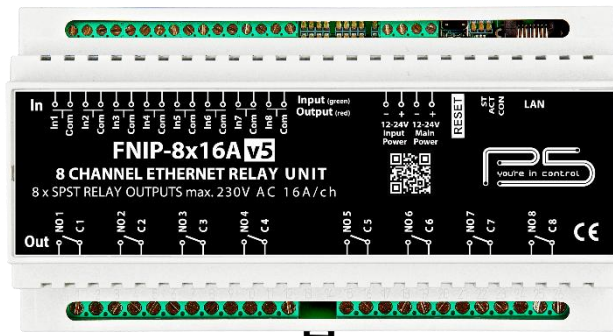

Standard

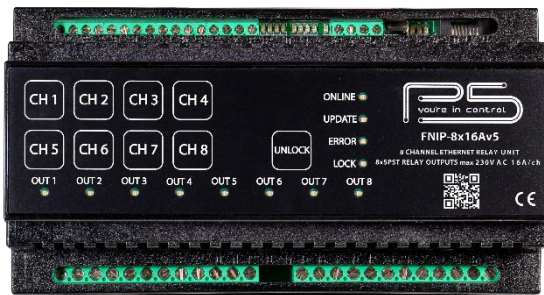

Pro

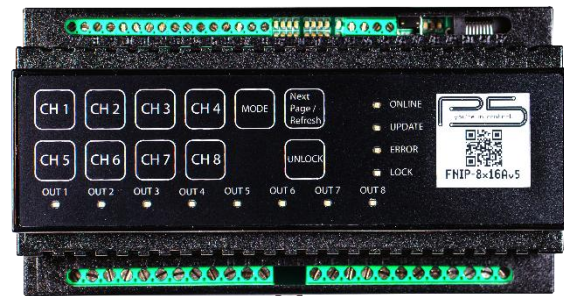

Premium

Figure 1. Three versions of the FNIP-8x16Av5 relay module

Table of Content

INSTALLATION	3
Terminal connections	3
Wiring diagrams	5
Outputs	6
Local Inputs	6
Status LEDs	6
CONFIGURATION	8
Configuration via the web interface	8
Network settings	10
Users and user rights	11
Channel settings	13
Scenes	14
Firmware Upgrade	15
Resetting to factory defaults	15
OPERATION	16
Operation via the local inputs	16
Input modes	16
Operation via the built-in web server	17
Control page	17
Input page:	17
Operation via TCP	18
TECHNICAL SPECIFICATIONS	20

INSTALLATION

WARNING!

This equipment shall be installed in a closed cabinet with no access to live parts. Only the top enclosure of the equipment (where the label is affixed) is allowed to be accessed by the operator.

Since the module is connected to mains/line voltage, it must be installed by a qualified electrician in accordance with local electrical codes.

Turn off power (main circuit breaker) before installation.

Terminal connections

Each module has a wiring diagram on the front which can help the installer when connecting the modules at installation sites. See Figure 2.

The terminal connections of the FNIP-8x16Av5 are listed in Table 1.

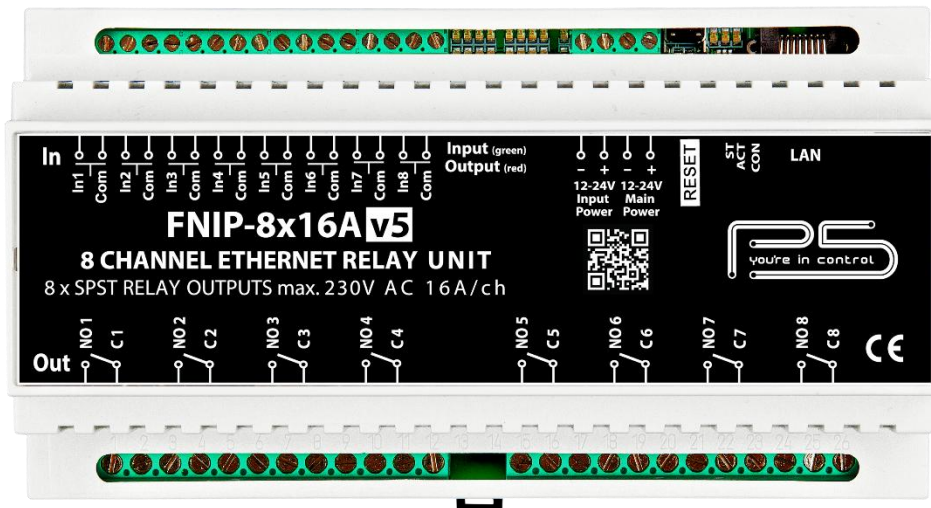

Figure 2. FNIP-8x16Av5 front view

Pos.	Description	Pos.	Description
1.	Output 1 N.O.	27.	Input 1
2.	Output 1 C.	28.	Com
3.		29.	Input 2
4.	Output 2 N.O.	30.	Com
5.	Output 2 C.	31.	Input 3
6.		32.	Com
7.	Output 3 N.O.	33.	Input 4
8.	Output 3 C.	34.	Com
9.		35.	Input 5
10.	Output 4 N.O.	36.	Com
11.	Output 4 C.	37.	Input 6
12.		38.	Com
13.	-	39.	Input 7
14.	-	40.	Com
15.	Output 5 N.O.	41.	Input 8
16.	Output 5 C.	42.	Com
17.		43.	Power for the Inputs -
18.	Output 6 N.O.	44.	Power for the Inputs + (12V - 24V DC)
19.	Output 6 C.	45.	Power for the Main Circuit -
20.		46.	Power for the Main Circuit + (12V - 24V DC)
21.	Output 7 N.O.	47.	-
22.	Output 7 C.	48.	-
23.		49.	-
24.	Output 8 N.O.	50.	LAN
25.	Output 8 C.	51.	
26.		52.	

Table 1: FNIP-8x16A.v5 terminal connectors

Wiring diagrams

Input Wiring diagram

The FNIP-8x16Av5 offers dry contacts inputs as shown in the following diagram.

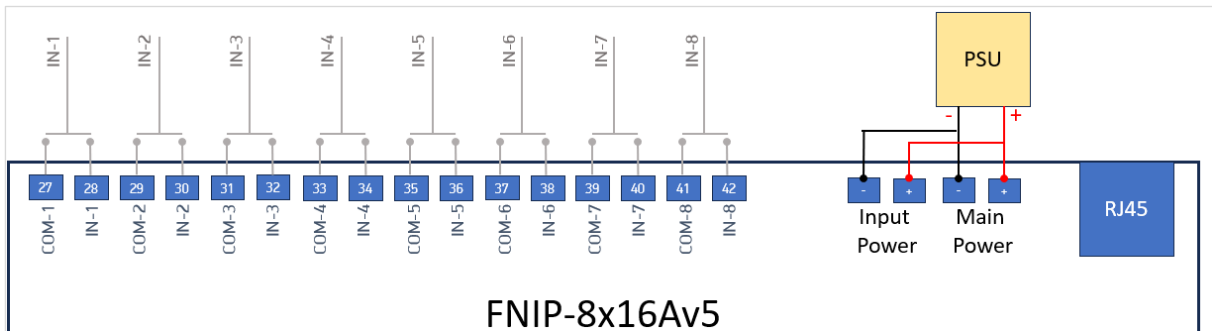

Output Wiring diagram

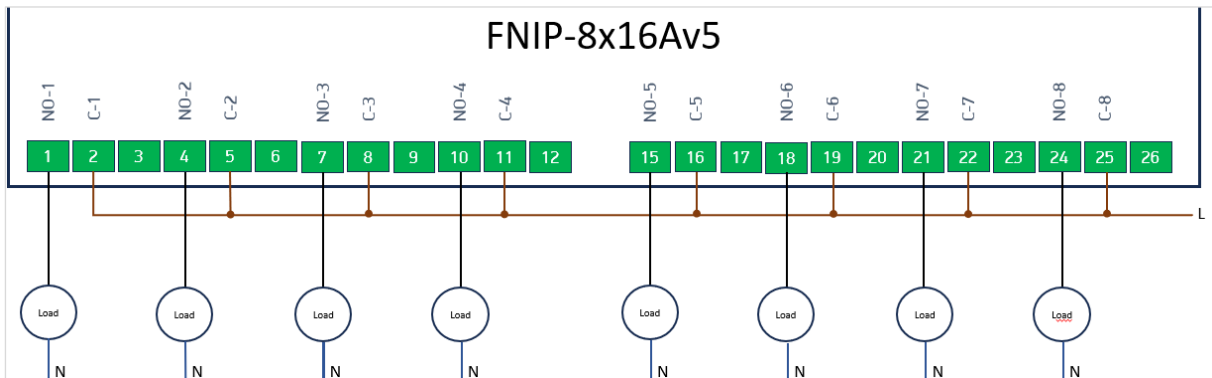

All outputs in this example are used to switch line voltage on the same phase. Connecting different phases in adjacent relay outputs is also possible. Since the outputs provide dry contacts, any voltage that doesn't exceed the specifications can be switched.

After installation, check if the outputs can be toggled via the inputs (only applicable if input power is connected across terminals 43-44.) The status LEDs will assist you in tracking the status of the inputs and outputs.

Recommended wire types

- Ethernet cable: Twisted pair, CAT5 or better.
- Outputs: According to the load attached to the outputs (current and voltage ratings).

- Inputs: A pair of low voltage cable. The inputs use low voltage signals. All wires used and the way they are run must be in accordance with the local electrical codes.

Please pay attention to the correct polarity.

The galvanic isolation of the inputs is only effective if a separate power supply is used for powering the inputs. The FNIP-8x16A.v5 has separate power input terminals (43 and 44) for this purpose. If you choose not to use the extra protection the isolated inputs offer, you can use the same power supply for both the main circuit and the inputs. In that case, simply connect terminal 43 to terminal 45 and terminal 44 to terminal 46.

Outputs

The FNIP-8x16Av5 has eight heavy duty relay outputs. Almost any equipment used in households or offices can be switched directly with the output relays. However, if the load exceeds the specifications, an additional relay (e.g. contactor) must be connected between the output and the load (for example in case of saunas, three-phase equipment, driveway heaters, industrial machines, etc.)

All outputs have dry contacts, no power is provided for the connected circuits.

Local Inputs

For each output, there is a local input to allow for manual operation.

Connect dry contacts (pushbuttons, standard or momentary switches, relay contacts, FN Touchpads) to trigger (activate) the inputs.

All input circuits are optically isolated to protect the main circuit of the module against unwanted effects of ground loops, overvoltage or misconnections.

To ensure an additional level of safe and reliable operation, the inputs are also software protected against the effects of noise spikes that usually occur when heavy inductive loads (motors, fans, etc.) are switched nearby.

Status LEDs

In order to make installation and debugging easier, communication and channel statuses are displayed via LEDs.

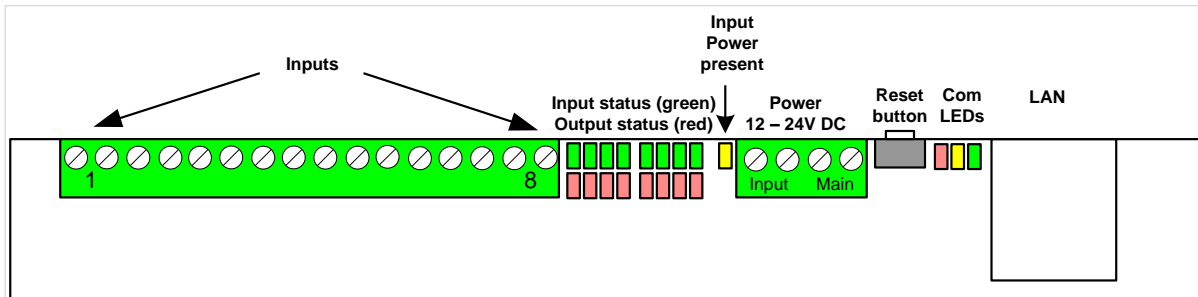

Figure 4. The board layout of the FNIP-8x16Av5 (top section)

Input & Output status LEDs

Each input/output has a dedicated status LED that illuminates green/red when the corresponding input/output is activated.

Input power LED

Indicates whether the input power is present.

Communication LEDs

Con LED - green

The Con LED is on when the module is connected to the Ethernet network.

Act LED - yellow

The Act LED indicates that communication via Ethernet is in progress.

St LED - red

The status LED indicates that the boot loader of the module is active. This should only happen during firmware update.

Please never disconnect power from the module while this LED is on!

If this LED stays on after the firmware update, contact your dealer!

CONFIGURATION

Configuration can be done either via the built-in website or via TCP/IP connection. In the latter case the configuration interface the third-party controller provides is used.

Configuration via the web interface

Use the FNIP Manager or the FNIP Network Discovery Utility software to discover all FutureNow IP devices on your network.

Connecting to the module's web server

After the modules are found you can click on one of them to open its website in a browser.

You can also access the module's internal website from an Internet browser using the host name (FNIP8x16A by default) or the IP address.

By default, each module obtains an IP address from a DHCP server automatically.

If there's no DHCP server available on the network, 192.168.1.25 will be assigned to the module. The same IP address will be used when connecting the module directly to your computer with an Ethernet cross cable.

Authentication

Once connected to the module's website, you will be asked to identify yourself, as seen in Figure 5.

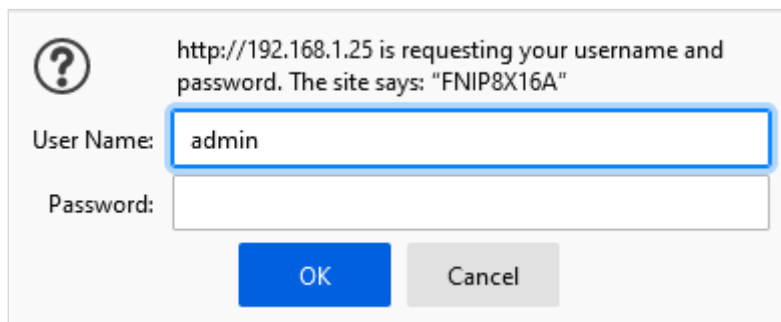

http://192.168.1.25 is requesting your username and password. The site says: "FNIP8X16A"

User Name:

Password:

OK Cancel

Figure 5. Authentication Window



The default user name: **admin**

The default password: **futurenow**

The default user has administrator rights and offer access to all settings and functions.

Once logged in, you will automatically be directed to the control page. you can see the details in the

OPERATION section.

You can use the tabs on the top of the screen to navigate between the different control and configuration pages.

Network settings

To make basic network settings click the **Network** tab. The network configuration page is shown in Figure 6.

You can choose between using DHCP or static IP address here.

Enable HTTP authentication

HTTP authentication can be disabled to make HTTP communication easier for third party applications.

Enable broadcast messages

FNIP modules periodically send out heartbeat broadcast messages with basic information about themselves. This helps discovery tools and mobile apps to find them. These broadcasts can be disabled if constant traffic on the network is not desirable.

Please note that disabling broadcast messages will disable the FNIP Manager and the Discovery Tool from finding the modules on the network.

Multicast address

Used to create groups of FNIP modules that react to scene activation commands received from a module with the same multicast address.

More information about scenes can be found in the Scenes chapter.

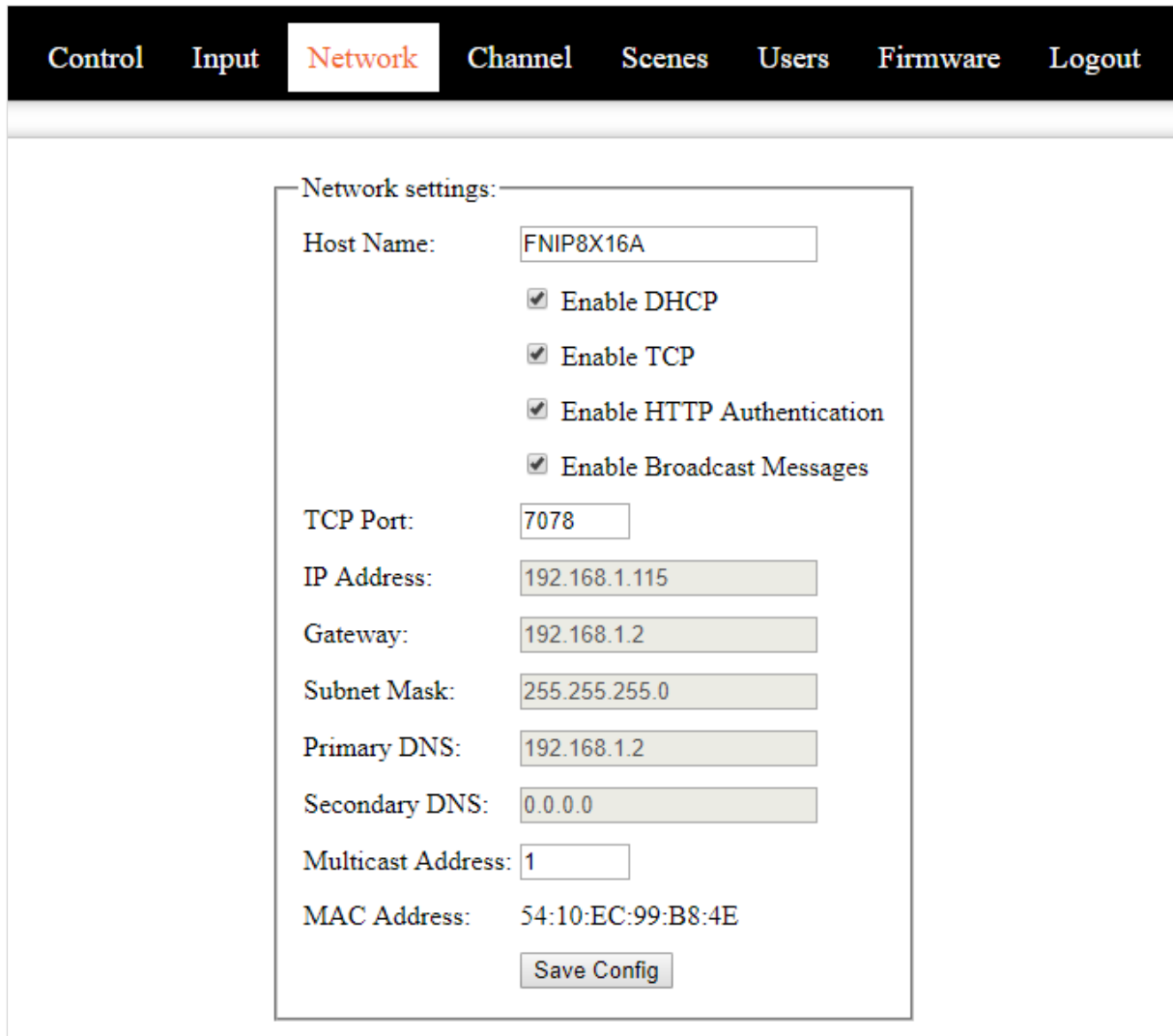

Figure 6. Network Configuration Page

Users and user rights

Three different users can be defined, each with three different user rights: **admin**, **actor** and **observer**.

Admins have access to all functions, including control of the outputs, monitoring the status of the inputs and outputs and changing all the settings.

Actors are allowed to control the outputs and monitor the status of the inputs and the outputs, but are not allowed to change any settings.

Observers are allowed to monitor the status of inputs and outputs but not allowed to control the outputs, nor can they change any settings.

To change user settings, click on the **User** tab in the top menu. The user configuration page is shown in Figure 7.

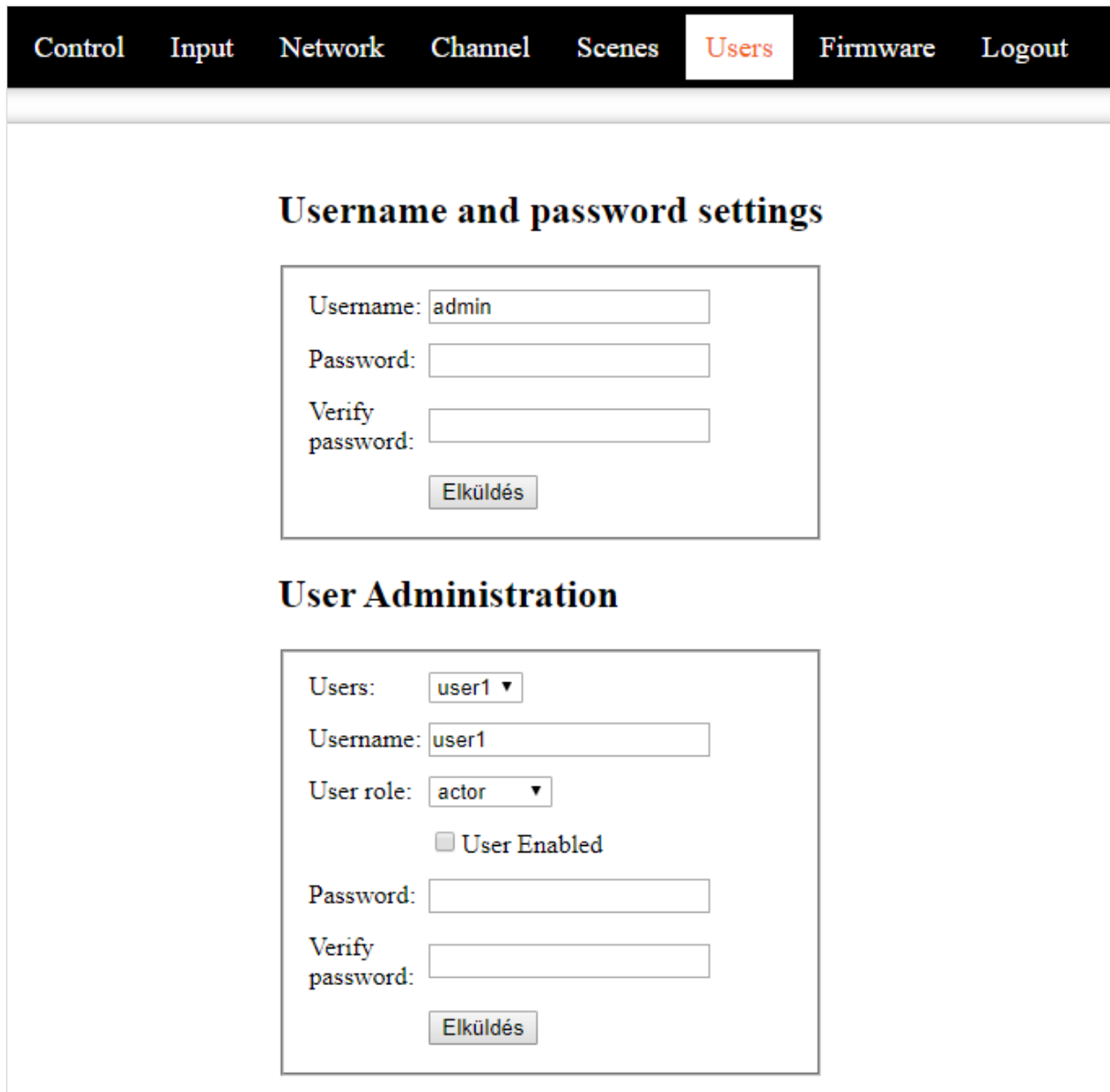

The screenshot displays the 'Users' configuration page. At the top, a navigation bar includes 'Control', 'Input', 'Network', 'Channel', 'Scenes', 'Users' (highlighted), 'Firmware', and 'Logout'. The main content area is divided into two sections:

- Username and password settings:** This section contains three input fields: 'Username:' with the value 'admin', 'Password:', and 'Verify password:'. Below these fields is a button labeled 'Elküldés'.
- User Administration:** This section contains a dropdown menu for 'Users:' with 'user1' selected, an input field for 'Username:' with 'user1', a dropdown menu for 'User role:' with 'actor' selected, a checkbox for 'User Enabled' which is unchecked, an input field for 'Password:', and an input field for 'Verify password:'. Below these fields is a button labeled 'Elküldés'.

Figure 7. User Configuration Page

Channel settings

On the **Channel** page the outputs and inputs can be renamed. Input modes can also be chosen here. The input mode determines the logical connection between the input and the output of the given channel. For details on possible input modes and how they work, see **Operation via the local inputs** section of this document.

Control	Input	Network	Channel	Scenes	Users	Firmware	Logout
Output labels:	Input labels:	Input modes:	Monostab. duration:	Scene no.	Inverted input	Inverted output	
<input type="text" value="Output 1"/>	<input type="text" value="Input 1"/>	<input type="text" value="Toggle"/>	<input type="text" value="10"/>	<input type="text" value="0"/>	<input type="checkbox"/>	<input checked="" type="checkbox"/>	
<input type="text" value="Output 2"/>	<input type="text" value="Input 2"/>	<input type="text" value="Switch"/>	<input type="text" value="10"/>	<input type="text" value="0"/>	<input type="checkbox"/>	<input type="checkbox"/>	
<input type="text" value="Output 3"/>	<input type="text" value="Input 3"/>	<input type="text" value="Switch"/>	<input type="text" value="10"/>	<input type="text" value="0"/>	<input type="checkbox"/>	<input type="checkbox"/>	
<input type="text" value="Output 4"/>	<input type="text" value="Input 4"/>	<input type="text" value="Monostab."/>	<input type="text" value="10"/>	<input type="text" value="0"/>	<input type="checkbox"/>	<input checked="" type="checkbox"/>	
<input type="text" value="Output 5"/>	<input type="text" value="Input 5"/>	<input type="text" value="Toggle"/>	<input type="text" value="10"/>	<input type="text" value="0"/>	<input type="checkbox"/>	<input type="checkbox"/>	
<input type="text" value="Output 6"/>	<input type="text" value="Input 6"/>	<input type="text" value="Toggle"/>	<input type="text" value="10"/>	<input type="text" value="0"/>	<input type="checkbox"/>	<input type="checkbox"/>	
<input type="text" value="Output 7"/>	<input type="text" value="Input 7"/>	<input type="text" value="Scene on open"/>	<input type="text" value="10"/>	<input type="text" value="2"/>	<input type="checkbox"/>	<input type="checkbox"/>	
<input type="text" value="Output 8"/>	<input type="text" value="Input 8"/>	<input type="text" value="Scene on close"/>	<input type="text" value="10"/>	<input type="text" value="1"/>	<input type="checkbox"/>	<input type="checkbox"/>	
Other settings:							
Resume light levels after power outage: <input type="checkbox"/>							
<input type="button" value="Save Settings"/>							

Figure 8. Channel Settings Page

Scenes

Scenes are predefined states of the outputs on the module.

FutureNow Scenes are developed to provide group commands for FutureNow modules. Any input of any module in the group can trigger any outputs in the same group of modules.

If a module receives a **Scene Activation Command (SAC)**, the designated outputs will go to a pre-defined state. SAC can be triggered by an input change on the same module or on any module in the group.

Each module in the group must have the same **Multicast address** set on the Network page. Modules in other groups will not react to the SAC.

	Output 1	Output 2	Output 3	Output 4	Output 5	Output 6	Output 7	Output 8
Scene 0	Off	Off	Off	Off	Off	Off	Off	Off
Scene 1	On	-	-	-	-	-	-	-
Scene 2	-	On	-	-	-	-	-	-
Scene 3	Off	-	Off	-	-	-	-	-
Scene 4	-	-	-	-	-	-	-	-
Scene 5	-	-	-	-	-	-	-	-
Scene 6	-	-	-	-	-	-	-	-
Scene 7	-	-	-	-	-	-	-	-
Scene 8	-	-	-	-	-	-	-	-
Scene 9	-	-	-	-	-	-	-	-

Global scenes: **Enabled** Enables scenes between other FNIP modules on the same subnetwork

Multicast address: 224.5.5.1

Save

Figure 9. Scene setting page

Firmware Upgrade

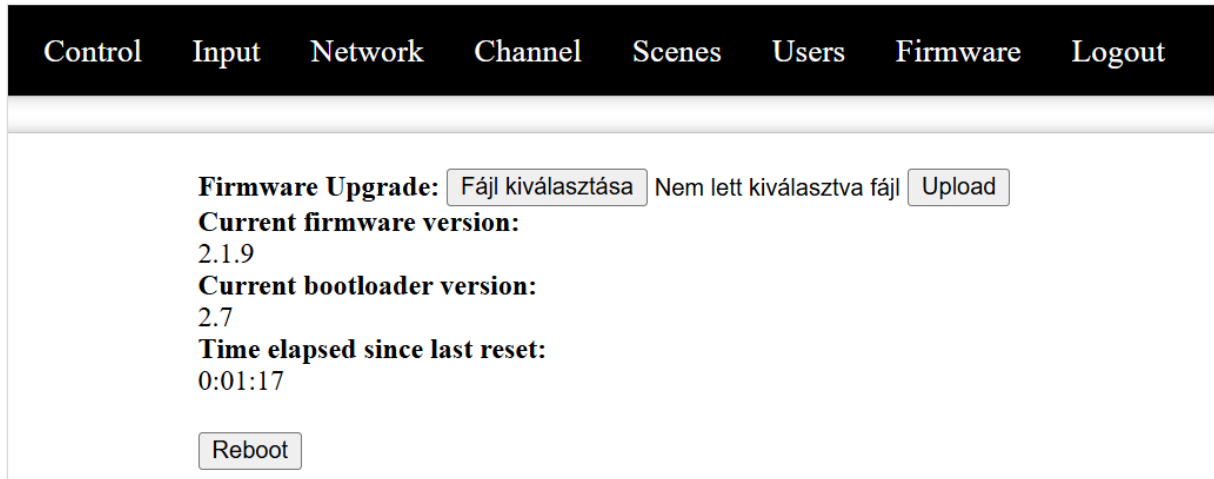

Figure 10. Firmware upgrade page

Upgrading the firmware in the module is possible via the network.

On the **Firmware** page click browse and find the new firmware on your PC. The latest firmware versions are always downloadable from P5's website. Then click **Upload**. The **St** LED turns on and stays on or blinks during firmware update. After uploading the new firmware – which takes about a minute – the module will automatically restart.

The current firmware version and the time since the last reset are also displayed on this page.

Resetting to factory defaults

Holding the reset button for at least 2 sec while powering up the module will set all the settings to factory defaults. **Make sure you release the button when the red LED comes on.**

OPERATION

Operation via the local inputs

The inputs can be activated by shorting (or opening) the appropriate input terminal.

Input modes

The inputs are factory defaulted to toggle mode and can be changed via the web interface of the module or by TCP/IP commands. The input modes work as follows.

1. Toggle mode (factory default)

Each short button press toggles the corresponding output

2. Independent inputs

Inputs can be detached from their corresponding outputs, in which case they will have no effect on them. However, the status changes of the digital inputs will still be reported via the open TCP/IP sockets and on the **Control** page of the built-in website. This can be used for monitoring the status of digital sensors connected to the inputs or to activate lighting scenes or macros whenever the input gets triggered.

3. Input follow mode

The status the outputs will follow the state of the corresponding input. The output will be on while the momentary switch is pressed and off while it is released.

4. Monostable mode

The outputs can be programmed to turn on for an adjustable amount of time when the corresponding input is triggered (e.g: staircase lighting).

5. Switch mode

This mode makes it possible to use maintained (standard light switches) instead of momentary switches on the inputs. Each trigger of the switch (On or Off) will toggle the outputs. Please note that the position of the switch – similarly to three-way switches – will not determine the status of the output.

6. Scene on open mode

If an input gets opened the scene assigned to the input on the channel configuration page will be executed.

7. Scene on close mode

If an input gets closed the scene assigned to the input on the channel configuration page will be executed.

Inverted mode

Detecting input opening can trigger the channel. This could be useful in Toggle, Monostable and Switch mode, when opening e.g. a storage room door opens the input circuit.

Operation via the built-in web server

Control page

Once logged in, you will automatically be directed to the control page, where you can control the **outputs** directly.

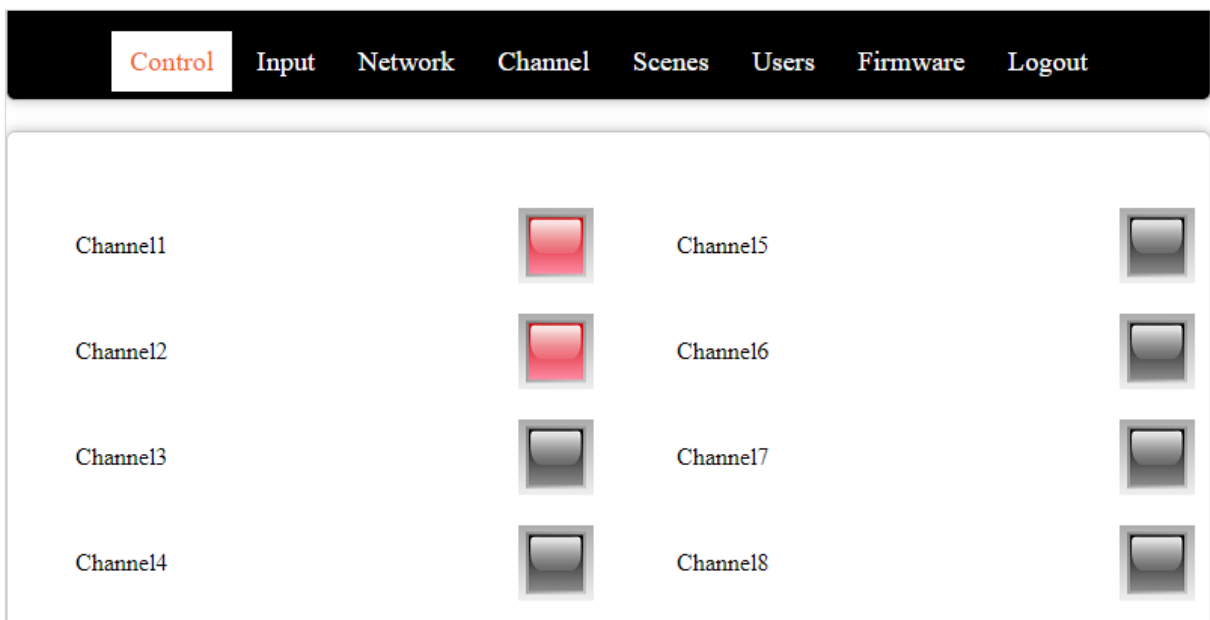

Figure 11. Control Page

Input page:

This page displays the logical status of the inputs.

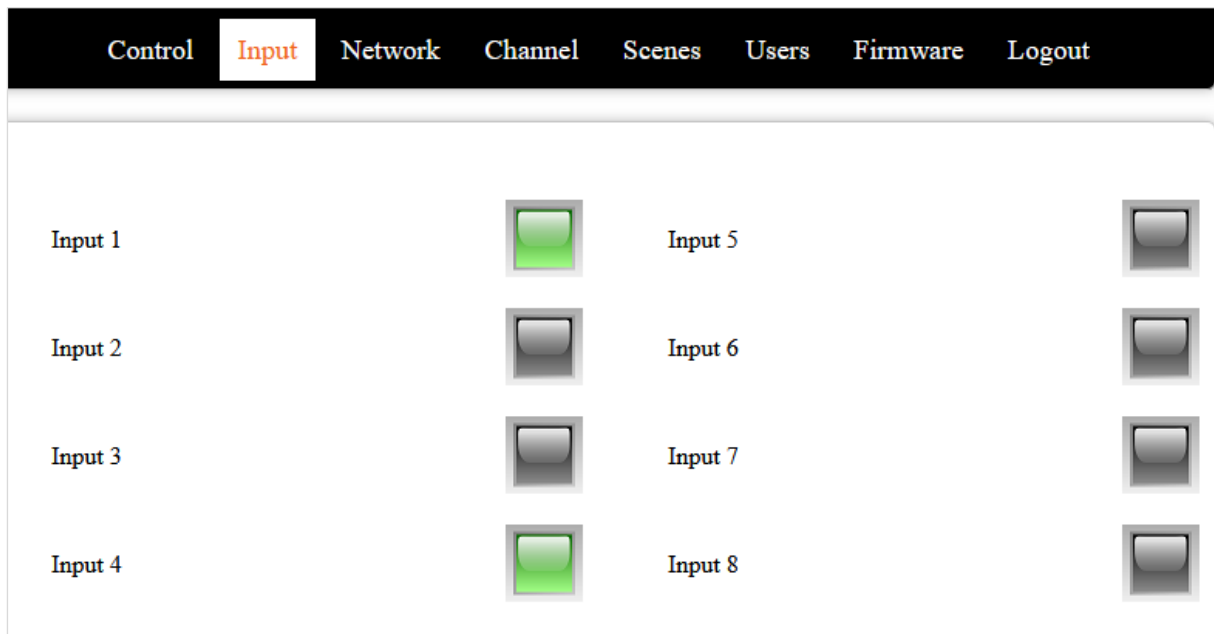

Figure 12. Input Page

Please note: If an input is inverted, then the logical status is the opposite of the actual status displayed by the LED.

Operation via TCP

To achieve the easiest integration with most controllers used in home and commercial applications, the module can be controlled by raw TCP protocol using simple ASCII based commands.

The TCP/IP communication can be enabled/disabled via the Network settings screen.

The TCP Communication Protocol Description is available upon request.

Event notifications

Automatic event notifications are sent to clients via the open socket connections whenever the status of an input or output changes.

Basically, any third-party controller that can implement the FNIP-8x16A's simple communication protocol can control the FutureNow FNIP-8x16A. The following controllers are the most widely used:

Control4, Savant, Crestron, AMX, RTI, Fibaro, Extron, Biamp, X-Stage, Lightware, Q-SYS, Kramer, Home Assistant.

Software modules/plugin for controllers are either available or P5 will provide full assistance in creating them.

Besides these special-purpose controllers, there have been many applications for embedded industrial PC boards, PCs and smartphones running Linux, Windows, Mac OS.

TECHNICAL SPECIFICATIONS

Power Requirements		
Main Circuitry	10.8 – 36 VDC max. 340mA @ 12V for the standard and pro versions max. 170mA @ 24V for the standard and pro versions max. 360mA @ 12V for the premium version max. 180mA @ 24V for the premium version	
Inputs	9 – 36 VDC max. 20mA @ 12V max. 45mA @ 24V	
Outputs		
Type	8 x SPST NO dry contacts	
Load	max. 16A@250VAC or 24VDC for resistive (cos(fi)=1) loads max. 8A@250VAC or 24VDC for inductive (cos(fi)=0.4) loads max. capacitive load 100µF (equivalent to approx. 250 W of LED load)	
In-rush current	max. in-rush current 80A/20ms	
Inputs		
Type	8 x optically isolated, noise protected, common GND digital inputs	
Communication		
Control	TCP (simple ASCII TCP commands) Build-in web server Local inputs (dry contacts, momentary switches)	
Input modes	Toggle, monostable, input follow, independent	
Interoperability	Drivers available for most systems	
Connectors		
Input Terminals	1.5mm ² screw terminals for the outputs	
Output Terminals	2.5mm ² screw terminals for the inputs	
Ethernet	RJ45 Ethernet Connector (10Mbps)	
Environmental		
Operating Temperature	0 °C – 40 °C (32 °F – 104 °F)	
Storage Temperature	-20 °C – 60 °C (-4 °F – 140 °F)	
Humidity	Up to 93%	
Physical		
Dimensions (H x W x D)	157 mm x 86 mm x 57 mm (9 DIN unit width)	
Weight	0.38Kg	
Installation	Standard DIN Rail Mount	
Approvals	Package Content	Warranty
CE	FNIP-8x16Av5	2 years

REFERENCES

FNIP Manager

FNIP Search Utility

FNIP TCP Communication Protocol Description

(Please email us at support@p5.hu to request the Communication Protocol Description)

CONTACT DETAILS

support@p5.hu

<http://p5.hu/index.php/support/contact-technical-support>